

Thumbwheel Switch

A7D/A7DP

Ultra-small, Low-cost, Push-operated Switches

- All-in-one design means fewer parts are required. This product delivers high reliability at a low cost.
- Uses long-lasting resin springs to achieve a long mechanical durability expectancy of 30,000 operations.
- Models with stoppers for restricting the setting range are available.
- The series includes a complete range of pen-push models that prevent accidental operation.



Ordering Information

Switches (Single Switch Units)

Model	A7D				A7DP	
	Screw mounting (back mounting)		Snap-in (front mounting)		Snap-in (front mounting)	
Classification (See note 1.)						
Output code	PCB terminals					
Terminals Color	Light gray	Black	Light gray	Black	Light gray	Black
06 (binary coded decimal)	A7D-106	A7D-106-1	A7D-206	A7D-206-1	A7DP-206	A7DP-206-1

Note: 1. The classification diagrams show 4 Switch Units combined with End Caps to create 4-digit displays.

2. The model numbers given above are for 1 Switch Unit.

3. Models with stoppers are also available. Add "-S□□" after the "106" or "206" in the model number and specify the display range in the □□. For example, to specify the range 0 to 6, add "-S06" to the model number (e.g., A7D-106-S06-1).

4. Models with +, - displays are also available. Add "-PM" after the "106" or "206" in the model number (e.g., A7D-106-PM or A7D-106-PM-1).

Accessories (Order Separately)

Use accessories, such as End Caps and Spacers, with the Switch Units.

Classification	Screw mounting (back mounting)		Snap-in (front mounting)	
	Light gray	Black	Light gray	Black
Accessory Color				
End Caps (1 pair)	A7D-1M	A7D-1M-1	A7D-2M	A7D-2M-1
Spacer	A7D-1P□ (See note.)	A7D-1P□-1 (See note.)	A7D-2P□ (See note.)	A7D-2P□-1 (See note.)

Note: The □ in the Spacer model number stands for a letter in the range A to U. (Refer to the table in the following explanation about Spacers.)

End Caps

End Caps are used on the Switch Units at each end and allow all the Switch Units to be securely mounted to a panel. They come in pairs, one for the left and one for the right.

Spacers

- Spacers are used for creating extra space or gaps between the Switch Units and have the same dimensions as the Switch Units themselves.
- There are also Spacers with engraved characters or symbols that can be used for indicating units, such as time and length. (Refer to the following table.) Consult your OMRON representative for details.

Symbol	A	B	C	D	E	F	G
Stamp	No designation	SEC	MIN	H	g	kg	mm
Symbol	H	J	K	L	Q	T	U
Stamp	cm	m	°C	PCS	x 10 SEC	0	•

Specifications

Switching capacity (resistive load)		5 to 30 VDC 1 mA to 0.1 A
Continuous carry current		100 mA
Contact resistance		200 mΩ max.
Insulation resistance	Between non-connected terminals	10 MΩ min. (at 250 VDC)
	Between terminal and non-current carrying part	100 MΩ min. (at 500 VDC)
Dielectric strength	Between non-connected terminals	250 VAC, 50/60 Hz for 1 min
	Between terminal and non-current carrying part	1,000 VAC, 50/60 Hz for 1 min
Vibration resistance		10 to 55 Hz, 1.5-mm double amplitude
Shock resistance		500 m/s ² min.
Durability	Mechanical	30,000 operations min.
	Electrical	20,000 operations min.
Ambient temperature		Operating: -10°C to 70°C (with no icing) Storage: -20°C to 80°C
Ambient humidity		Operating: 45% to 85%
Max. operating force		3.43 N max.

Dimensions

(Unit: mm)

Switches

A7D-106(-1)
PCB Terminals

(Unit: mm)

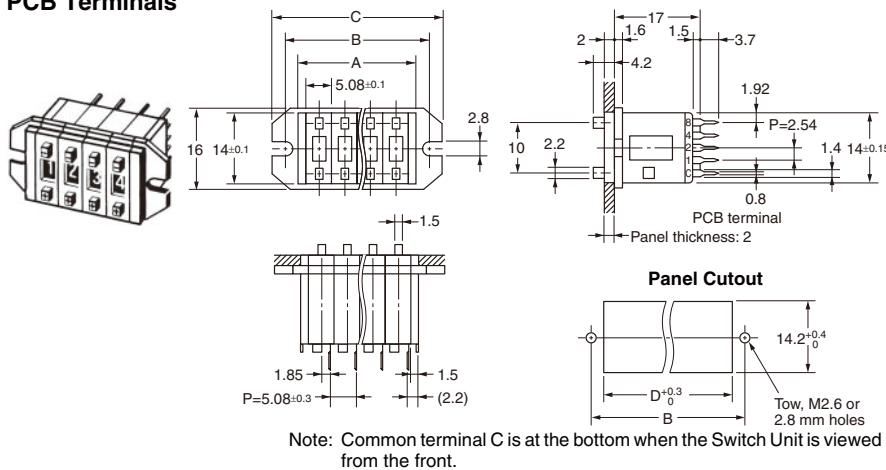

Number of Switches (n)	Size A (n x 5.1 + 3)	Size B (n x 5.1 + 8.3)	Size C (n x 5.1 + 13.3)	Size D
1	8.1	13.4	18.4	8.4
2	13.2	18.5	23.5	13.5
3	18.3	23.6	28.6	18.6
4	23.4	28.7	33.7	23.7
5	28.5	33.8	38.8	28.8
6	33.5	38.9	43.9	33.9
7	38.6	44.0	49.0	39.0
8	43.7	49.1	54.1	44.1
9	48.8	54.2	59.2	49.2
10	53.9	59.3	64.3	54.3

Note: 1. The dimensions above include both End Caps, and will increase 5.08 mm for each Spacer inserted.
2. Unless otherwise specified, a tolerance of ±0.4 mm applies to all dimensions.
The tolerance for multiple connection is ±(number of units x 0.4) mm.

A7DP-206(-1)
PCB Terminals

(Unit: mm)

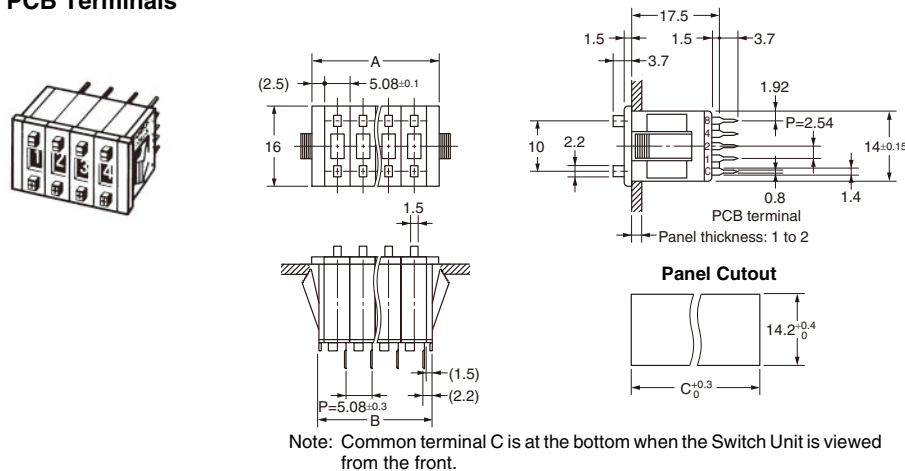

Number of Switches (n)	Size A (n x 5.1 + 5)	Size B (n x 5.1 + 3)	Size C (n x 5.1 + 3.9)
1	10.1	8.1	9
2	15.2	13.2	14.1
3	20.3	18.3	19.2
4	25.4	23.4	24.3
5	30.5	28.5	29.4
6	35.5	33.5	34.5
7	40.6	38.6	39.6
8	45.7	43.7	44.7
9	50.8	48.8	49.8
10	55.9	53.9	54.9

Note: 1. The dimensions above include both End Caps, and will increase 5.08 mm for each Spacer inserted.
2. Unless otherwise specified, a tolerance of ±0.4 mm applies to all dimensions.
The tolerance for multiple connection is ±(number of units x 0.4) mm.

A7DP-206(-1) PCB Terminals, Pen-push Model

(Unit: mm)

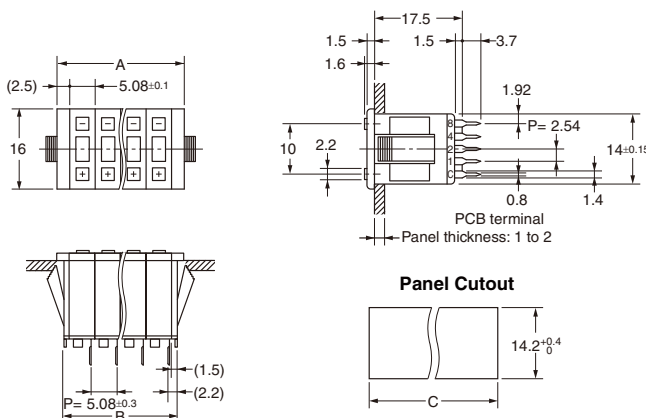

Note: Common terminal C is at the bottom when the Switch Unit is viewed from the front.

Number of Switches (n)	Size A (n x 5.1 + 5)	Size B (n x 5.1 + 3)	Size C (n x 5.1 + 3.9)
1	10.1	8.1	9
2	15.2	13.2	14.1
3	20.3	18.3	19.2
4	25.4	23.4	24.3
5	30.5	28.5	29.4
6	35.5	33.5	34.5
7	40.6	38.6	39.6
8	45.7	43.7	44.7
9	50.8	48.8	49.8
10	55.9	53.9	54.9

Note: 1. The dimensions above include both End Caps, and will increase 5.08 mm for each Spacer inserted.
2. Unless otherwise specified, a tolerance of ± 0.4 mm applies to all dimensions. The tolerance for multiple connection is $\pm(\text{number of units} \times 0.4)$ mm.

Accessories (Order Separately)

End Caps for Push-operated Switches A7D-1M(-1) Screw Mounting (Back Mounting)

Left Side

Right Side

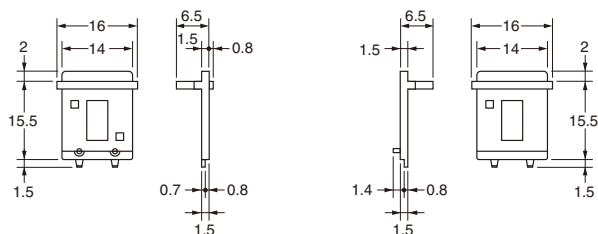

End Caps for Push-operated Switches A7D-2M(-1) Snap-in Mounting (Front Mounting)

Left Side

Right Side

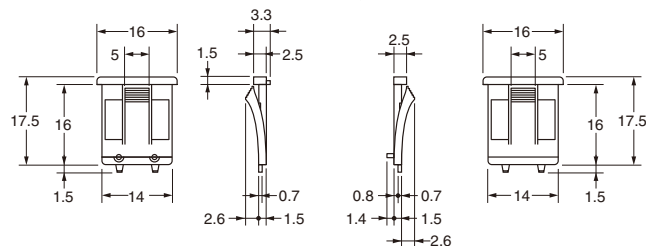

Spacers for Push-operated Switches A7D-1P□(-1) Screw Mounting (Back Mounting)

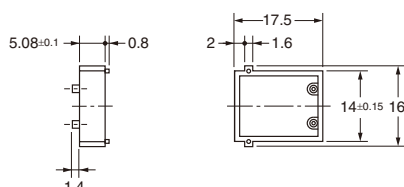

Note: The □ in the Spacer model number stands for a letter in the range A to U. (Refer to the table under the explanation about Spacers on page 1.)

Spacers for Push-operated Switches A7D-2P□(-1) Snap-in Mounting (Front Mounting)

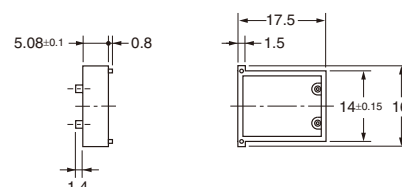

Note: The □ in the Spacer model number stands for a letter in the range A to U. (Refer to the table under the explanation about Spacers on page 1.)

Note: Unless otherwise indicated, dimensional tolerances for dimensions in the models above are ± 0.4 mm.

Output Codes

Output code number		06 (Binary Code)				
Internal circuit						
Dial display	Terminal	C	1	2	4	8
0						
1			●			
2				●		
3			●	●		
4					●	
5			●		●	
6				●	●	
7			●	●	●	
8						●
9			●			●

Note: The solid dot ● indicates that the internal switch is ON (i.e., connected to the common terminal).

Ordering Procedure

Place orders as shown in the example below, specifying the model and number.

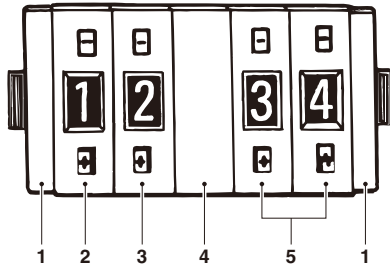

1. A7D-2M (End Caps): 1 pair
2. A7D-206-S□□ (Switch Unit with stopper): 1 piece
3. A7D-206 (Switch Unit): 1 piece
4. A7D-2P□ (Spacer): 1 piece
5. A7D-206 (Switch Unit): 2 pieces

Note: Standard products, such as the Switch Units and End Caps, are not factory-assembled for shipment. Contact your OMRON representative for details on ordering factory-assembled sets.

Safety Precautions

Refer to *Precautions for Correct Use* on in the *Technical Guide for Thumbwheel Switches*.

Precautions for Correct Use

Handling

- The molded components of the Switch use polyacetal resin and PBT resin. It is recommended that alcohol is used to wipe off dirt and smudges from the molded components. Take care to prevent the alcohol from getting inside.
- Do not use thinner or other solutions which might damage the resin.
- Terminals can withstand a force of 4.9 N for 10 seconds or more (the mating strength of the case and seal), and survive bending of 20° without breaking after returning to original position. Do not use excessive force or apply repetitive external force, however, when handling terminals. In particular, take care to avoid dropping them as the terminals might bend or break.

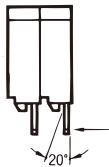

- The setting buttons can withstand 19.6 N for 1 minute, but do not push the (+) and (-) buttons at the same time.

Soldering

- Using a Soldering Iron

Use a 30-W soldering iron at a temperature of 350°C for a maximum of 3 seconds, and flush as described above.

Do not apply force to the terminals during soldering and for 3 minutes after soldering is completed. Doing so may result in conduction or operation failure.

Ensure that soldering flux and alcohol do not penetrate into the Switch interior

Setting Numbers

Pen-push Type

Press the setting switch with the tip of a ball-point pen. Do not use pencil point or mechanical pencil point to press the setting switch, otherwise the lead of the pencil or mechanical pencil may be broken and A7DP malfunctions may result due to fragments of the broken lead.

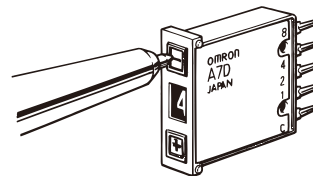

Screw-mounting Models

Tighten mounting screws to a torque between 0.2 to 0.24 N·m, using M2.6 screws. Use plain washers or spring washers together with the screws.

Safety Precautions for All Thumbwheel Switches

For precautionary information on individual products, refer to *Safety Precautions* in the relevant section.

 **WARNING**

Electric shock may possibly occur. Do not perform wiring work or touch the charged parts of terminals while power is supplied to the Switch.



Precautions for Correct Use

For details, refer to *Precautions for Correct Use of Thumbwheel Switches* in *Technical Guide for Switches and Level Control Equipment*.

Technical Guide for Thumbwheel Switches

Precautions for Correct Use

Environment

- Do not use where gases are generated (ammonia, chlorine, sulfur dioxide).
- Although Switches are of nearly dust-proof construction, they are not drip-proof, therefore do not use in areas subject to water or oil exposure and do not operate with wet or oily hands. (The A7MD has a dust-proof construction on contact parts, but consider your installation location carefully. The A7MA is not of dust-proof construction.)
- Provide additional dust-proofing measures, such as using a dust-proof cover, when using in sand-exposed areas.

Storage

Do not store Switches in areas subject to high temperature or high humidity, or store them in room-temperature areas for extended periods of time. Doing so may cause oxidation of the terminals or problems with solder. It is also recommended that long periods of storage be avoided in general.

Handling

- **Wiring**
After wiring has been completed, ensure an appropriate insulation distance.
- **Set-up**
Do not use the Switch in the normally-pressed state. Doing so may occasionally result in premature deterioration of parts and changes in the characteristics.
- Do not touch charged parts, such as terminals, while the power is ON.
- Do not connect more than one power supply to a single Switch. Doing so may result in circuit malfunctions and short-circuits.
- When changing settings, do not touch the operating buttons if your fingers are wet or there is oil or any other foreign substance on your fingers.
- It is recommended that alcohol is used to wipe off dirt and smudges from the molded-plastic cases. Take care to prevent the alcohol from getting inside.
- Do not use thinner or other solutions which might damage the plastic.
- When connecting Switches, fit the mating parts together.
- When separating Switches, use a screwdriver as shown in the figure below; disconnect them by releasing the top and bottom hooks. Be careful not to bend the hooks.

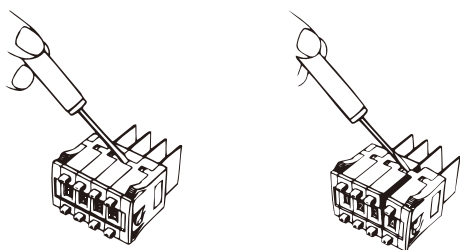

- Do not push the (+) and (-) operating push-buttons at the same time.
- Do not drop the Switch. Doing so may possibly result in deformation of the terminals, damage to the PCB, or damage to the resin catch (for connecting) on the side of the Switch.
- The output may be unstable while the pushbuttons are being pressed due to the structure of the Thumbwheel Switch. Read the output signal only after the display has stopped moving.

Models with PCB Terminals

- When using models with PCB terminals, make the terminal insertion holes in the back board (mother board) 1 mm or larger in diameter.
- Do not use excessive force in handling models with PCB terminals. In particular, take care to avoid dropping them as the terminals might bend or break.

Reference: Terminals can withstand a force of 7.84 N for 1 minute or more (A7D: 4.9 N for 10 seconds or more), and survive bending of 20° without breaking after returning to original position. Withstanding the repetitive application of external pressure, however, is beyond the scope of Switch specifications.

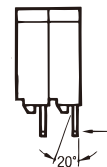

Connectors

- Insert Connectors while keeping the arrow pointing up (refer to A7BS/A7BL and A7PS/A7PH for details).
- Connector insertion load is about 14.7 N for each A7B-C and 34.3 N for each NRT-C.

Soldering

Note the following points when soldering printed circuit boards:

- **Automatic Soldering**
Do not use dip cleaning. Doing so may result in flux penetration of the Switch interior, causing contact and rotational defects. Clean the flux as shown in Figure 1, tilting the Switch 80° or less and using a brush to apply the solvent only to the back of the board. It may also be cleaned by dipping only the back of the board into the solvent and then using a brush to clean.
- **Dip Soldering**
When applying flux solvent, the dipping time is a maximum of 2 seconds. As shown in Figure 2, avoid flooding the top surface of the printed circuit board with flux. Using a brush to apply flux further reduces the danger of flux penetration. When cleaning flux with a brush, tilt the Switch 80° or less, as shown in Figure 1, in order to prevent flux from flowing onto the switch mounting surface. Clean flux as described above under *Automatic Soldering*.

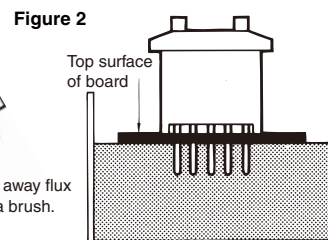
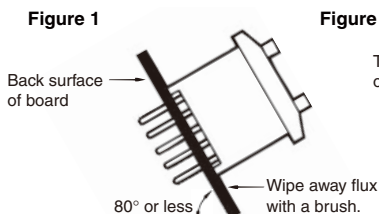

- **Using a Soldering Iron**
Use a 30-W soldering iron at a temperature of 350°C for a maximum of 3 seconds, and flush as described above. Do not apply force to the terminals during soldering and for 3 minutes after soldering is completed. Doing so may result in conduction or operation failure.
- Ensure that soldering flux and alcohol do not penetrate into the Switch interior

Read and Understand This Catalog

Please read and understand this catalog before purchasing the products. Please consult your OMRON representative if you have any questions or comments.

Warranty and Limitations of Liability

WARRANTY

OMRON's exclusive warranty is that the products are free from defects in materials and workmanship for a period of one year (or other period if specified) from date of sale by OMRON.

OMRON MAKES NO WARRANTY OR REPRESENTATION, EXPRESS OR IMPLIED, REGARDING NON-INFRINGEMENT, MERCHANTABILITY, OR FITNESS FOR PARTICULAR PURPOSE OF THE PRODUCTS. ANY BUYER OR USER ACKNOWLEDGES THAT THE BUYER OR USER ALONE HAS DETERMINED THAT THE PRODUCTS WILL SUITABLY MEET THE REQUIREMENTS OF THEIR INTENDED USE. OMRON DISCLAIMS ALL OTHER WARRANTIES, EXPRESS OR IMPLIED.

LIMITATIONS OF LIABILITY

OMRON SHALL NOT BE RESPONSIBLE FOR SPECIAL, INDIRECT, OR CONSEQUENTIAL DAMAGES, LOSS OF PROFITS, OR COMMERCIAL LOSS IN ANY WAY CONNECTED WITH THE PRODUCTS, WHETHER SUCH CLAIM IS BASED ON CONTRACT, WARRANTY, NEGLIGENCE, OR STRICT LIABILITY.

In no event shall responsibility of OMRON for any act exceed the individual price of the product on which liability is asserted.

IN NO EVENT SHALL OMRON BE RESPONSIBLE FOR WARRANTY, REPAIR, OR OTHER CLAIMS REGARDING THE PRODUCTS UNLESS OMRON'S ANALYSIS CONFIRMS THAT THE PRODUCTS WERE PROPERLY HANDLED, STORED, INSTALLED, AND MAINTAINED AND NOT SUBJECT TO CONTAMINATION, ABUSE, MISUSE, OR INAPPROPRIATE MODIFICATION OR REPAIR.

Application Considerations

SUITABILITY FOR USE

OMRON shall not be responsible for conformity with any standards, codes, or regulations that apply to the combination of products in the customer's application or use of the product.

At the customer's request, OMRON will provide applicable third party certification documents identifying ratings and limitations of use that apply to the products. This information by itself is not sufficient for a complete determination of the suitability of the products in combination with the end product, machine, system, or other application or use.

The following are some examples of applications for which particular attention must be given. This is not intended to be an exhaustive list of all possible uses of the products, nor is it intended to imply that the uses listed may be suitable for the products:

- Outdoor use, uses involving potential chemical contamination or electrical interference, or conditions or uses not described in this catalog.
- Nuclear energy control systems, combustion systems, railroad systems, aviation systems, medical equipment, amusement machines, vehicles, safety equipment, and installations subject to separate industry or government regulations.
- Systems, machines, and equipment that could present a risk to life or property.

Please know and observe all prohibitions of use applicable to the products.

NEVER USE THE PRODUCTS FOR AN APPLICATION INVOLVING SERIOUS RISK TO LIFE OR PROPERTY WITHOUT ENSURING THAT THE SYSTEM AS A WHOLE HAS BEEN DESIGNED TO ADDRESS THE RISKS, AND THAT THE OMRON PRODUCT IS PROPERLY RATED AND INSTALLED FOR THE INTENDED USE WITHIN THE OVERALL EQUIPMENT OR SYSTEM.

Disclaimers

CHANGE IN SPECIFICATIONS

Product specifications and accessories may be changed at any time based on improvements and other reasons.

It is our practice to change model numbers when published ratings or features are changed, or when significant construction changes are made. However, some specifications of the product may be changed without any notice. When in doubt, special model numbers may be assigned to fix or establish key specifications for your application on your request. Please consult with your OMRON representative at any time to confirm actual specifications of purchased product.

DIMENSIONS AND WEIGHTS

Dimensions and weights are nominal and are not to be used for manufacturing purposes, even when tolerances are shown.

ERRORS AND OMISSIONS

The information in this catalog has been carefully checked and is believed to be accurate; however, no responsibility is assumed for clerical, typographical, or proofreading errors, or omissions.

PERFORMANCE DATA

Performance data given in this catalog is provided as a guide for the user in determining suitability and does not constitute a warranty. It may represent the result of OMRON's test conditions, and the users must correlate it to actual application requirements. Actual performance is subject to the OMRON Warranty and Limitations of Liability.

PROGRAMMABLE PRODUCTS

OMRON shall not be responsible for the user's programming of a programmable product, or any consequence thereof.

COPYRIGHT AND COPY PERMISSION

This catalog shall not be copied for sales or promotions without permission.

This catalog is protected by copyright and is intended solely for use in conjunction with the product. Please notify us before copying or reproducing this catalog in any manner, for any other purpose. If copying or transmitting this catalog to another, please copy or transmit it in its entirety.